

# **TRONE**

**INSTRUCTION MANUAL  
G2ETBCERN-12.WH**

**GANZA II**

## SAFETY PRECAUTIONS

Basic safety precautions must be followed when handling or using electrical products, especially those within the reach of children. Please make yourself aware of the following guidelines:

- This product should only be used by children who are 8 years and older or by persons with disabilities who have received supervision and instructions on the safe use and the hazards involved when using this product.
- It is unwise to allow children to play with this electronic bidet, supervised or not.
- It is not recommended that children who are unsupervised be allowed to clean and perform maintenance for this product.

## SIGNS AND MEANINGS



**WARNING**

Improper operations due to ignorance of the instructions may result in death or injury.



**CAUTION**

Improper operations due to ignorance of the instructions may result in body injury and property loss



**FORBID**

Not allowed



**MUST**

Should be followed



## WARNING

Please do not touch the electrical outlet with wet hands.

- Or it may cause electric shock

Please do not pour liquids such as water or detergent on top of the electronic outlet and the toilet.

- Or it may cause fire, electric shock, heat or short circuit
- Or it may cause injury and indoor water seepage because of the damaged part

Never attempt to disassemble, repair, or alter the product yourself.

- Or it may cause fire, electric shock, heat or short circuit

Please do not install the toilet in the car, ship, or any other moving objects.

- Or it may cause fire, electric shock, short circuit or fault
- Or the ceramic, seat, and the main part will be damaged due to fall

Do not use if it is broken. Under the following condition, please turn off the toilet and the water angle valve.

- Water leakage from the pipe or inner parts of the toilet
- Smoke
- Unusual heating and smell
- Blockage
- Fall out of the cushion

- Continuous use of the toilet despite of the damages and above-mentioned conditions may result to fire, electric shock, heat, short circuit, injury, and indoor water seepage.

Please don't use seawater and other water except for tap water or potable well water (underground water)

- Or it may cause skin irritation or inflammation

During thunderstorms, do not touch the electrical plug

- Or it may cause electric shock

Please do not let the water inlet soft pipe connect to the electrical plug and outlet





## WARNING

- Or it may cause fire, electric shock, heat, and short circuit because of moisture condensation

Please do not damage the power cable or plug. Do not strike, yank, twist, bend excessively, or alter the electrical cords. Also, do not place anything heavy on, bind or pinch the cords

- Or it may cause fire, electric shock, heat, and short circuit if it's broken

Please do not use a loose or faulty electrical outlet

- Or it may cause fire or short circuit

Please use the electrical outlet and wire appliance in the specified outlet

- Or it may cause fire

Please do not put your finger or anything into the warm air outlet. Do not cover or put objects or clothes on the air outlet.

- Or it may cause scalding, electric shock, or fire

Pay attention to the low temperature scalding

- Improper use of warm seat may cause low temperature scalding.

If you sit for a long time, please turn the temperature setting to "off" level. Please turn the seat temperature setting to "off" level, warm air dry temperature to "low" level under the following situations

- Children and elders or those who cannot adjust the temperature to the proper level
- Persons with disability and patients with behavioral problems
- People who have taken medicines with side effects of hypnosis (hypnotics, cold meds, etc.), or those who are excessively drinking alcohol, too tired, and with somnolence.

This is an electrical product, please do not install it in a place where it will get wet easily or in areas with high humidity. If installed in the bath-ram, please install a ventilator to maintain the bathroom ventilation.

- Or it may cause fire or electric shock

	<p>The product must be connected to the cold water supply</p> <ul style="list-style-type: none"><li>• Or it may cause body burn or machine fault</li></ul> <p>Please confirm if the electrical outlet is connected to the ground.</p> <ul style="list-style-type: none"><li>• Or it may cause electric shock because of fault or short circuit.</li></ul> <p>The outlet for power wire should obey the following rules or it may cause fire or electric shock.</p> <p>Please ask the maintenance team or similar department to replace the power soft wire if it is broken to avoid danger. Repair work must be done by professionals.</p> <p>Please do not throw lighted cigarettes and other flaming material into the toilet.</p> <ul style="list-style-type: none"><li>• Or it may cause fire</li></ul> <p>Do not install this product in a room where it may be frosted. The room temperature can't be less than 39.2 degree Fahrenheit.</p> <p>Don't block the air outlet.</p>
---	--



## CAUTION

	<p>Do not use excessive force when closing the cover and the seat.</p> <p>Do not intentionally soil, spray, or block the cleaning nozzle.</p> <p>Pull out the plug regularly and clean off the dust with a dry cotton cloth.</p> <p>Use the new hose parts that come with the product. The old ones should not be reused.</p> <p>Keep the product away from the heater.</p> <p>Close the water supply valve before taking out the junction block.</p> <p>If you need to be away for a long time, be sure to plug it out, turn off the water, and drain the remaining water inside the bidet. The remaining water may freeze when the product is transported over long distances or stored for a long time in cold winter or alpine region.</p>
---	--

# LINE DRAWINGS

## Remote Control

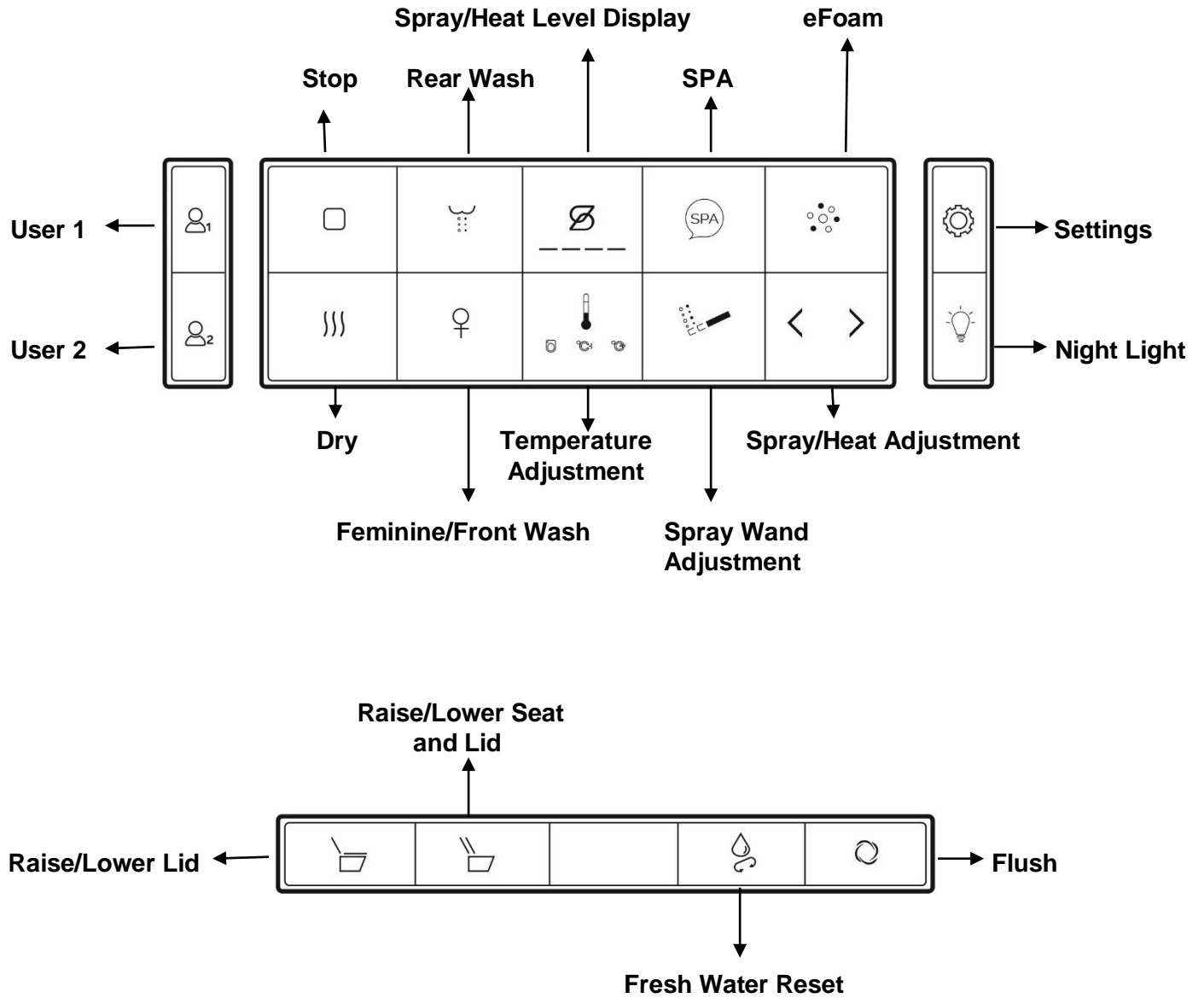

# Electronic Bidet

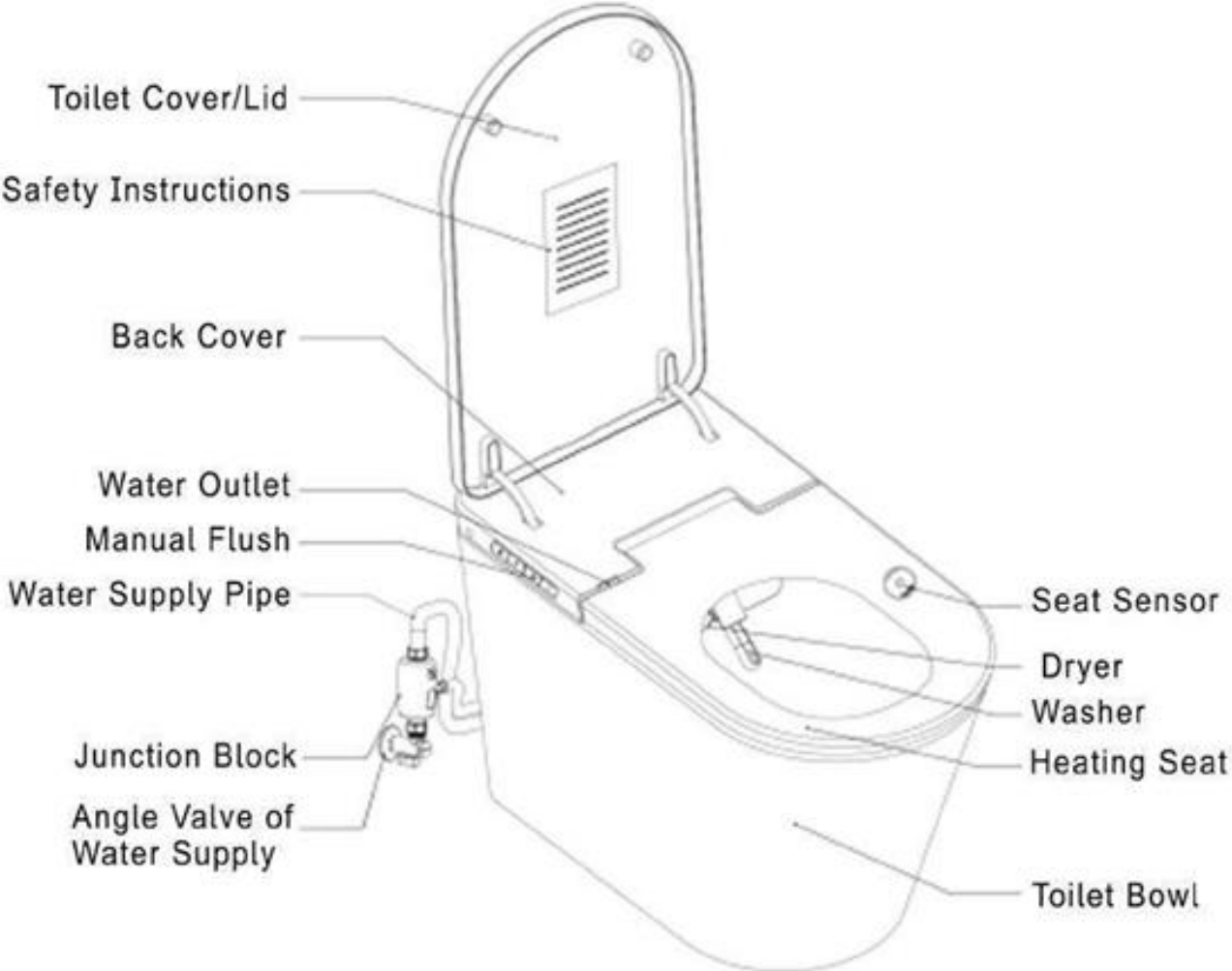

# Side Buttons

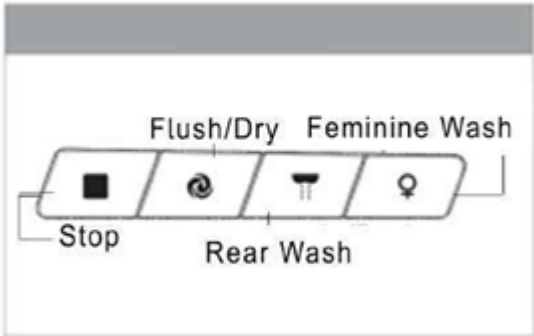

## FEATURES

<b>Feature</b>	<b>Description</b>
Rear Wash	Provides cleansing on the back part
Feminine Wash	Provides cleansing on the front or feminine area
SPA Function	Provides a soothing pulsating effect whenever desired
Auto Flush	Automatically flushes after every use
Bowl Pre-Rinse	Automatically cleanses the bowl before every use
SyphonAssist Flush	Uses a strong syphoning action to flush dirt away
Battery Backup Flush	Includes a battery that would allow Auto Flush function even during power outages
Self-Cleaning Wand	Automatically cleanses the spray wand after every use
Power Saving/Eco Mode	Has preset settings designed to conserve energy
Foot Sensor	Allows the user to raise the seat and the lid with just the use of one foot
Soft Close Seat/Lid	Seat/lid closes slowly to prevent noise caused by banging of the seat and the lid
Night Light	Provides light at night for clearer visibility
Deodorizer	Removes foul odor
eFoam	A unique technology that uses deodorizing foam spray



# OPERATION

## Stop

- When the power is off, long press it for more than 2 seconds to turn the power on.
- When the power is on, long press it for more than 2 seconds to turn the power off.
- Short press this button [Stop] to terminate the following functions: rear wash, lady wash, strong & weak massage, cold & warm massage, children wash, self-cleaning of nozzle, drying, and live water replacement.

## Rear Wash

- When the user is seated, press this button [Rear Wash] to start rear washing. The pipe reciprocating function opens by default which will increase the cleaning area. Press the [Rear Wash] button again to stop the pipe reciprocating function.
- Short press the [Stop] button to stop Rear Wash. It will stop cleaning and start the drying function automatically after continuous cleaning for about 90 seconds.

## Feminine Wash

- When the user is seated, press this button [Feminine Wash] to start feminine washing. The pipe reciprocating function opens by default which will increase the cleaning area. Press the [Feminine Wash] button again to stop the pipe reciprocating function.
- Short press the [Stop] button to stop Feminine Wash. It will stop cleaning and start the drying function automatically after continuous cleaning for about 90 seconds.

## Drying

- When the user is seated, press this [Dry] button to start the drying function.
- Short press the [Stop] button to stop Drying. It will stop automatically after continuous drying for about 5 minutes.

## Water Pressure Adjustment

- When you're washing, press this button to go to the mode of water pressure adjustment (default).
- Press the > button to increase the cleaning intensity.
- Press the < button to reduce the cleaning intensity.

## Spray Wand Position Adjustment

- When you're washing, press this button to go to the mode of spray wand position adjustment.
- Press the > button to move the spray wand position forward.
- Press the < button to move the spray wand position backward.

## Temperature Adjustment



- Press this button to go to the mode of water temperature adjustment.

- Press the > button to increase the water temperature.
- Press the < button to decrease the water temperature.



- Press this button to go to the mode of seat temperature adjustment.
- Press the > button to increase the seat temperature.
- Press the < button to decrease the seat temperature.



- Press this button to go to the mode of fan temperature adjustment.
- Press the > button to increase the fan temperature.
- Press the < button to decrease the fan temperature.

## Gear Position Indicator Light

- The ——— [Gear Position Indicator Light] will display the current gear position.
- The *water pressure adjustment, spray wand position adjustment, and the temperature adjustments* have four gear positions: Close, Low, Mid, and High. If it is out of gear position, the unit responds with two beeps showing the operation is invalid. The correct operation has only one beep.

Close

Low

Mid

High

## SPA

- When the user is seated, long press the [SPA] button for more than 2 seconds to start the SPA function.
- When the SPA function is open, it will start the Memory Cleaning function, Gear Position, Strong & Weak Massage, and Hot & Cold Massage functions.
- Long press the [Clean Guard] button once more for more than 2 seconds to close the Stop & Weak Massage and Hot & Cold Massage functions.
- Short press the [Stop] button to stop the SPA function. After that, continue cleaning for about 5 minutes and then it will stop washing and switch to drying automatically.

## Strong & Weak Massage

- Long press the  [Rear Wash] button to turn on/off the Rear Wash function when the user is seated. The water pressure starts changing. The corresponding relationships between the gear position of strong & weak massage and water pressure are as follows:
 

Water Pressure: Close, Low	Strong & Weak Massage: Low
Water Pressure: Mid	Strong & Weak Massage: Mid
Water Pressure: High	Strong & Weak Massage: High

## Cool & Warm Massage

- Long press the  [Feminine Wash] button to turn on/off the Cool & Warm Massage when

the user is seated. The water temperature starts changing from low to high. The corresponding relationships between the gear position of strong & weak massage and water pressure are as follows:

Water Pressure: Close, Low  
Water Pressure: Mid  
Water Pressure: High



Cool & Warm Massage: Low  
Cool & Warm Massage: Mid  
Cool & Warm Massage: High

## Children Wash

- Long press the  [User] button for more than 2 seconds when the user is seated. The cleaning wand is extended to the set position and clean according to the set water temperature. It stops automatically after 90 seconds. This function presets the water pressure for children washing specially.

Note: Water temperature, water pressure, spray wand position selection, reciprocating, and massage functions can't be adjusted when this function starts.

## Power Saving/Eco Mode

- Press and hold the  [Setting] button then press the  [Night Light] button to turn on/off the Power Saving/eco mode. When it turns on, the side knob shown a green light. When it turns off, the side knob shows a white light. The seat temperature will keep in range of 77 °F to 96.8 °F intelligently according to the change of environment temperature. If the seat temperature set by the user is lower than the intelligent setting temperature, it will keep the temperature set by the user. It will keep the temperature set by the user after exiting the Power Saving/Eco Mode.

Note: Power Saving/Eco Mode means to low down the seat temperature when nobody uses the toilet.

## Night Light

- Press the  [Night Light] button in the remote to turn this function on/off. When turning the function on, the Gear Position button on the remote lights up while the toilet's soft light lights up. Press the button once more to turn off the function.

## Deodorization

- The deodorizing function starts after the user is seated.
- The deodorizing function stops after the user leaves the seat for around 60 seconds.
- When the user is sitting and the drying or cleaning function is off, short press the [Stop] button to stop deodorizing.



## Cover Flipping Function

- When the user is leaving the seat, press the  [Cover Flip] button to open or close the cover. If the seat is open, it will close the seat and the cover together.
- It will open the cover automatically when you are close to it if the automatic cover flip function is set in the single open mode.

Note: The automatic cover flip function is only valid when the cover is closed.

## Setting The Automatic Cover Flip

### *Factory Settings: On*



- Press and hold the  [Setting] button, then press the  [Cover Flip] button to turn the automatic cover flip function on/off.
- It will not open the cover automatically when you are close to it if the automatic cover flip function is off (it will give a short beep instead).
- It will open the cover automatically when you are close to the toilet if the automatic cover function is on (a long beeping sound will be heard).

## **Seat Flip Function**

- When the user is leaving the seat, press the  [Seat Flip] button to open or close the seat. If the seat is closed, it will open the seat and the cover together.
- It will open the cover and the seat automatically one by one when you are close to it if the automatic seat flip function is set in the Fully Open Mode.  
Note: The automatic seat flip function is valid only when the cover and the seat is closed.



## **Setting The Automatic Seat Flip Function**

### *Factory Settings: On*



- Press and hold the  [Setting] button, then press the  [Seat Flip] button to turn on/off the automatic seat flip function.
- It will not open the cover automatically when you are close to it if the automatic seat flip function is off (it will give a short beep instead).
- It will open the cover automatically when you are close to the toilet if the automatic cover function is on (a long beeping sound will be heard).

## **Setting The Automatic Drying Function**



### *Factory Settings: On*

- Press and hold the  [Setting] button, then press the  [Dry] button to turn on/off the automatic drying function.
- It will not switch to the drying function automatically after washing if the automatic drying function is off (it will give a short beep instead).
- It will switch to the drying function automatically after washing if the automatic drying function is on (a long beeping sound will be heard).

## **User Function**

- Press the  [User] button to change to a different user's personal mode one by one.
- The  [Gear Position Indicator Light] shows the currently selected user's settings (four gear position lights correspond to four users). The selected settings of the User mode will be used automatically. The functions performed at this time are all according to the corresponding parameter settings.
- In User mode, user's adjustment about water flow, temperature, and position will be automatically saved for later memory.
- The remote will exit the personal mode after entering into the standby state for some while.

## **Setting of Sensing Distance (Cover Flip/Seat Flip)**

- Press and hold the  [Setting] button, then press the  [Gear Position +] or [Gear Position -] button to set the sensing distance.
- Press the < [Gear Position -] button to decrease the sensing distance.
- Press the > [Gear Position +] button to increase the sensing distance.
- The  [Gear Position Indicator Light] button will display the current operating direction.
- The sensing distance has five gear positions I, II, III, IV, and V. If it is out of gear position, the machine responds with two beeps showing the operation is invalid (the correct operation has only one beep).

## Fresh Water Replacement

- Please use this function to replace the water inside the bowl first when you do not use the toilet for a long time. It's normal that water drains under the baffle when the fresh water is replaced.
- Long press the  [Flush] button to start this function. It will stop automatically after it's completed.
- Press the [Stop] button if you wish to stop this function.

## Self-Cleaning Wand

- When the user is leaving the seat, long press the  [Rear Wash] button on the toilet. The spray wand will then extend and water will come out.

## Automatic Flush

- Press and hold the [Setting] button, then press the [Flush] button to turn this function on/off. When the function is turned on, it will respond with a short beeping sound. When you turn it off, it will respond with a long beeping sound.
- The toilet flushes automatically only in the Automatic Flush Mode. The specific operation is shown in the following illustration:

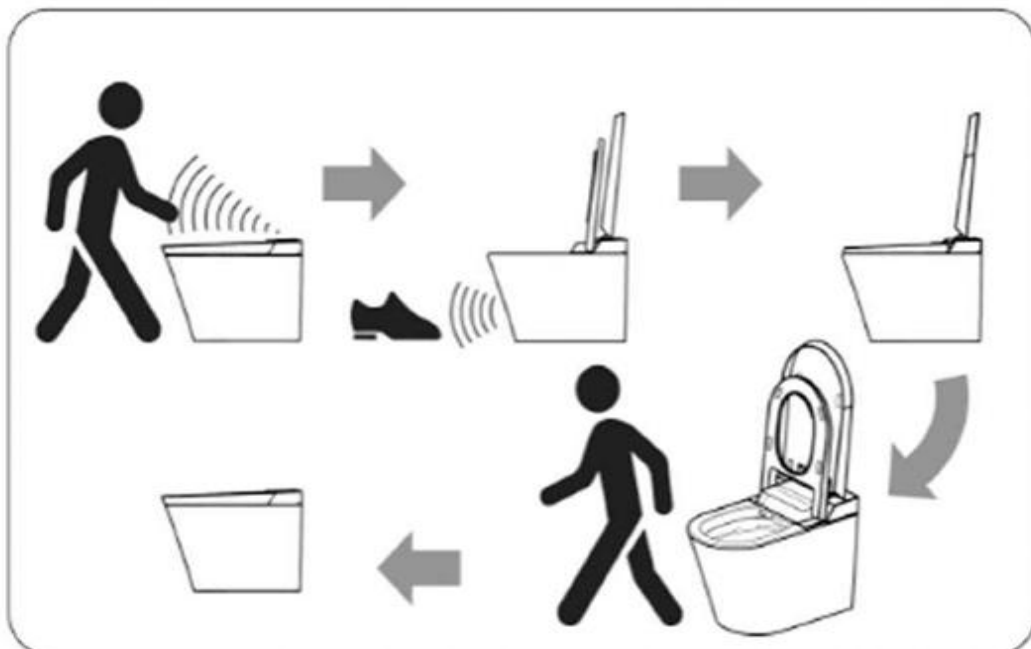

## Adjusting The Flush Time

-  Press and hold the side Feminine Wash button for 8 seconds to enter into the Flush Time Adjustment function and adjust the pulse valve time.
- The first step: The green light flashes (0.5s dark 0.5s bright) during the pulse valve 1's flushing time adjustment. Use the remote control [gear position +] and the [gear position -] to adjust the time, add or minus 0.5s one at a time. The adjustment range is 4 to 10 seconds; then press the side button for feminine wash entering into the second step: pulse valve 2's sewage time adjustment. At this time, yellow light flashes. Please follow the same adjustment process indicated above.
- Then short press the side button for Feminine Wash to enter into the third step: pulse valve 1's water return time adjustment, At this time, the red light flashes. The adjustment method is the same as the first step.
- Press the side Feminine Wash button to leave the Pulse Valve Time Adjustment Function.
- Except for the side Feminine Wash button or the button for water pressure and spray wand position in the remote, all other buttons can exit the adjustment function.
- If the flush time adjustment has reached the limit, there will be a beeping sound that will indicate operation failure when adjusting. The default flushing times are 5s, 6s, 7s, and the adjustment range is 4 to 10 seconds.

## MANUAL FLUSH KEYS

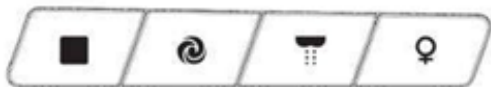

	<b>On/Off</b>
	<b>Stop</b>
	<b>Flush</b>
	<b>Dry</b>
	<b>Rear Wash</b>
	<b>Reciprocating</b>
	<b>Feminine Wash</b>
	<b>Reciprocating</b>

## PAIRING THE REMOTE WITH THE BIDET

- Unplug the bidet (tripping the GFCI on the plug will also work).
- Press and hold the SPA button until the 4 lights on the front of the remote start flashing. Then release the SPA button.
- Hold the remote close to the electronic bidet combo and at the same time proceed to step 4.
- Plug in the toilet (or reset the GFCI) and listen for the beep. Once the beep sounds, you will have successfully paired your remote control with your toilet bidet combo.

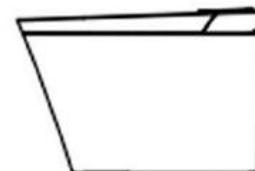

# TROUBLESHOOTING GUIDE

## Power Switch

Fault	Failure Analysis	Solutions
Product Not Working	Check whether the socket is electrified or not and the plug if loosened or not	Check circuit
	Check whether the toilet is turned on or not (if the side button is on or not)	Press the power on/off button until the side button's light is on
	Check whether the leakage protection button in the plug is on or off by checking the light of the leakage protection plug	Pull out the plug and connect it later. Press the reset switch of the leakage protection plug. If it's still not working, pull out the plug and ask a professional repair man for help.

## Rear Wash/Feminine Wash

Fault	Failure Analysis	Solutions
No water coming out from the nozzle	Check if there's no water supply	Wait for water supply to be back to normal
	Check if the angle valve is closed or not	Open the angle valve
	Check if the inlet water filter is blocked or not	Clean the water filter
	Check if the water inlet pipe is bended or not	Ensure that the inlet pipe
Cleaning strength is not enough	Check the water pressure is in low gear or not	Increase the water pressure using the remote
	Check inlet filter blocked or not	Clean the inlet filter
Water temperature is not warm enough	Check if the water temperature is set to low or not	Adjust the water temperature according to the instructions given in this manual
Spray wand is always dripping water	Solenoid valve failure	Consult a professional repair man
Spray wand cannot be used	Seat body induction failure	Consult a professional repair man

## Dryer/Fan/Seat Temperature

Fault	Failure Analysis	Solutions
Drying with cold air	Check the fan temperature setting if it's off or low	Adjust the fan temperature according to the manual
Seat is not warm enough	Check the seat temperature setting if it's off or low	Adjust the seat temperature according to the manual

## Remote Failure

Fault	Failure Analysis	Solutions
Remote not working	Low battery	Replace the old battery
	Check if there's any water inside the remote	Dry the remote with a dry cotton cloth

## Toilet

Fault	Failure Analysis	Solutions
Unclean flush when the water pressure is low	Angle valve filter blocked	Clean the filter according to the manual
	Too low water pressure	Measure if the water volume is 10L per 30s or not (buy a booster pump)
	Bended water inlet pipe	Ensure that the water supply line is not kinked
Normal water pressure but flush is unclean and has no siphon	Outlet has air leakage	Consult a professional repair man
	S-pipe is blocked	Use a toilet dredge
Normal water pressure but flush is not working	Check if the angle valve is closed or not	Open the angle valve
	Flush valve failure	Consult a professional repair man



## Common Problems

Fault	Failure Analysis	Solutions
No water	Check if the water source is open or not	Open the water source
	Check if the water supply angle valve is open or not	Open the water supply angle valve
	Check if the water supply angle valve filter net is blocked or not	Clean the filter net
Water leakage at the joint	Check if the joint is tightened or not	Tighten the joint
	Check if the inside seals of joint is aged or damaged	Replace the seals
	Check if the water supply angle valve is fully open or not	Completely open the water supply angle valve
Water flow becomes lower	Check if the water supply angle valve filter net is blocked or not	Clean the filter net
	After cleaning the water supply angle valve net, the water flow is still low.	Replace the filter
Device leakage	Check if the seals are damaged	Replace the seals
	The water supply angle valve doesn't match with the unit.	Replace with suitable parts

## CLEAN AND CARE

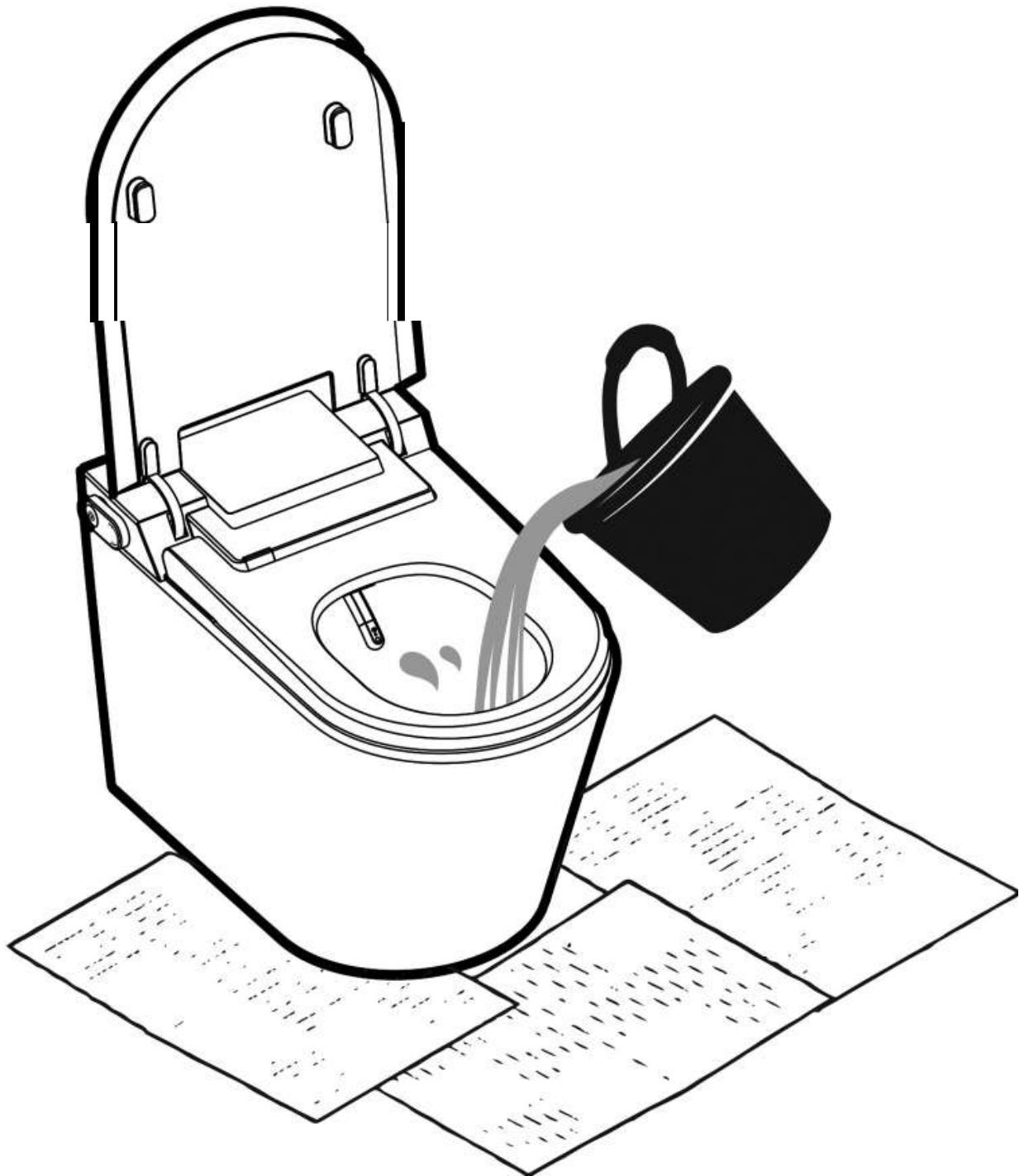

Note: Turn off the power, close the water supply angle valve, and stop the water supply before doing any maintenance work. DO NOT rinse this product with water during maintenance.

## Toilet Bowl Cleaning

- Please ensure that the electrical plug is taken out.
- Please use soft damp cloth to wipe the toilet shelf and seat. The dirt should be easily removed. If it's not, you may use neutral detergent

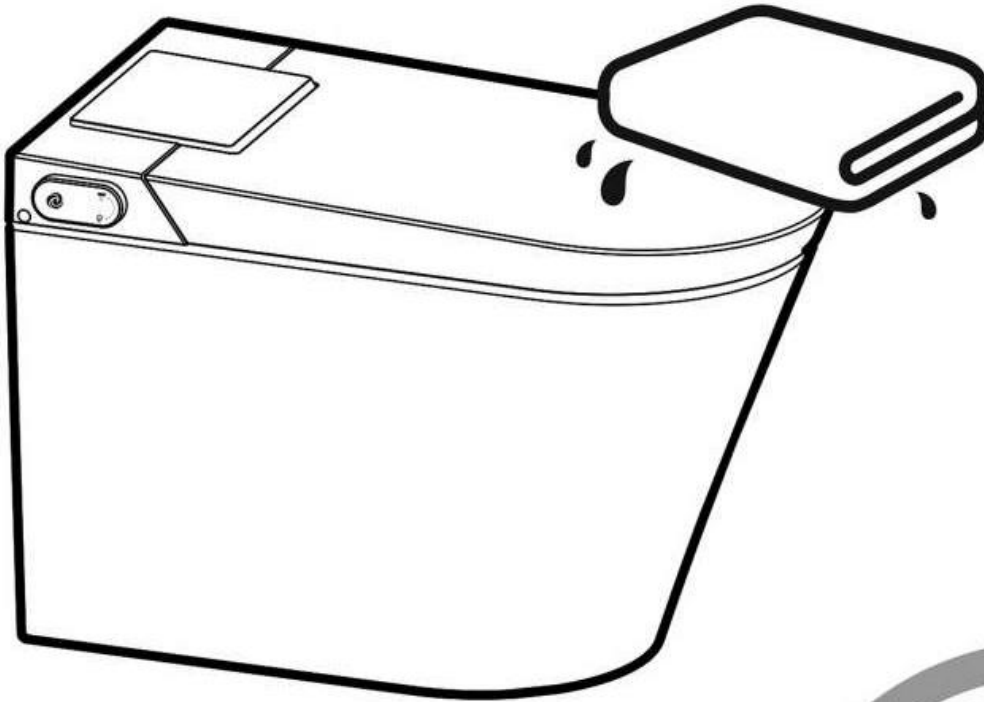

## Self-Cleaning Nozzle Maintenance

- Wash the cleaning tube and nozzle with a toothbrush coated with toothpaste.
- Do not use excessive force. Press the side [Stop] button to take the nozzle tube back once you're done cleaning.

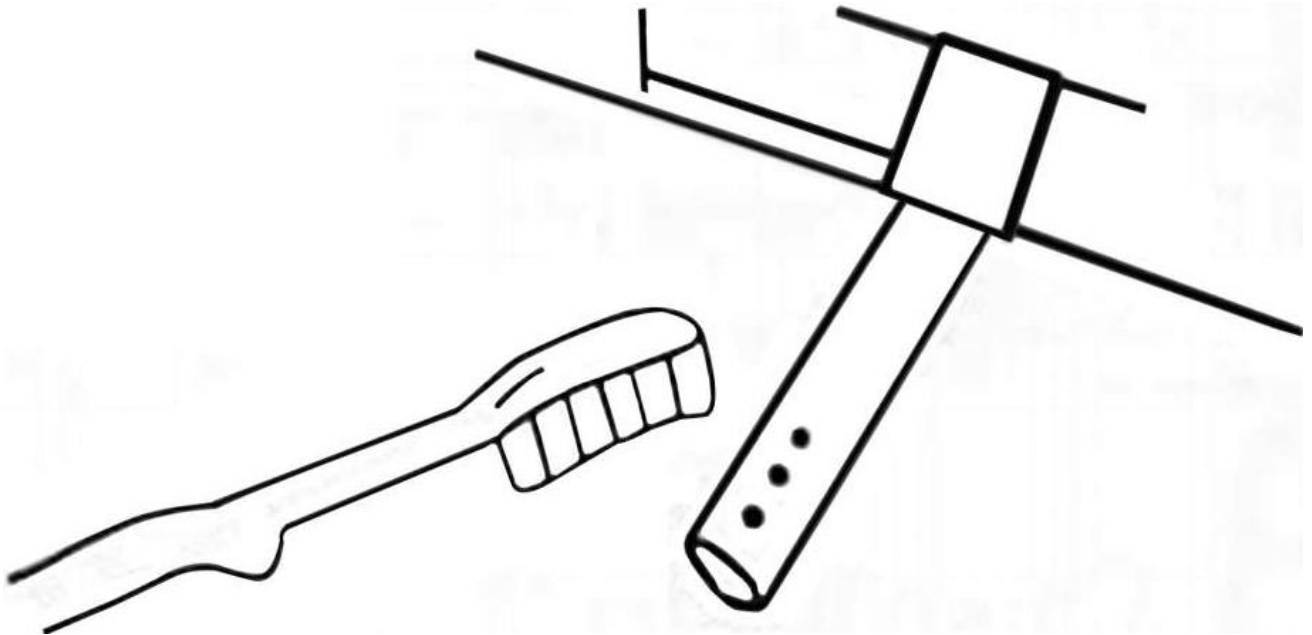

## Cleaning The Junction Block

- The junction block is installed on the water supply angle valve. It can't be pressed by a foreign matter and must be away from any corrosive substances.
- The junction block should be installed away from heat sources such as heaters, Yuba lights, etc. It should be installed indoors and should not be exposed to sunny or cold weather.
- Please replace the junction block after it has reached the end of its service life.
- If you are not at home for a long time (due to travel, etc), please turn off the water supply angle valve.
- It is recommended to change the filter every 6 months.

## Cleaning The Steel Mesh Filter

- Please clean the steel mesh (or replace the filter) according to the local

water quality.

- When the cleaning strength becomes weaker, clean the steel mesh or replace the filter on time. Close the water supply angle valve when disassembling the filter. Tighten the filter during installation to avoid water leakage.
- Turn the filter counterclockwise with a coin to open the filter. It is recommended to clean the steel mesh every 1-2 months.

## Replacing The Battery

- Loosen the screws that secure the battery cover, remove the old battery and give it to a professional recycling agency.
- Replace the new battery and lock the fixing screw as shown in the picture.
- Refer to the battery installation picture to install the battery properly.
  - ❖ Keep the battery out of reach of children. Please confirm the positive and negative of battery. Do not change, disassemble, or burn the battery. Don't mix it with old batteries or different types of batteries to avoid leakage or explosion.
  - ❖ The battery case has a moisture-proof function. Please tighten the fixing screws to achieve a good sealing effect.

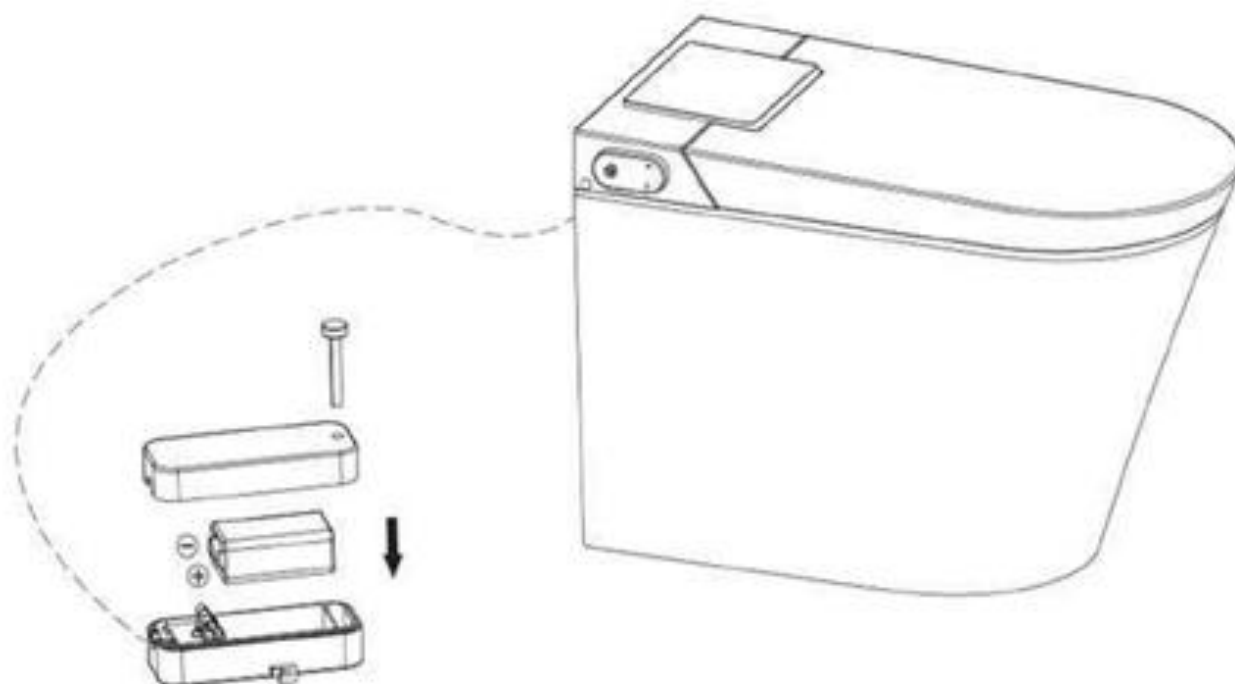

# PRODUCT SPECIFICATIONS

Rated Voltage	120V~, 60Hz
Rated Power	1150W
Power Cable	1.5m
Applicable Water Pressure	40 – 90 PSI
Water Temperature	39.2 to 95 °F
Ambient Temperature	39.2 to 104 °F
Net Weight	99.2 lbs
Waterproof Level	IPX4
Cleaning Water Flow	0.13 – 0.19 gpm (0.5 – 0.7L/min)
Seat Temperature Adjustment	Total 4 gears (Normal: around 104 °F)
Water Temperature Adjustment	Total 4 gears (Normal: around 104 °F)
Wind Temperature Adjustment	Total 4 gears (Normal: around 104 to 149 °F)
Cleaning Time	Normal cleaning is about 90 seconds, SPA cleaning is about 5 mins.
Nozzle Position Adjustment	4 gears
Heating Mode	Frequency Conversion Heat
Safety Device	Leakage Protection Switch, Wind/Seat/Water Temperature Protection
Deodorization	Nano Intelligent Deodorization

**Executive Standard:** GB4706.1 GB4706.53

**Note:** Rated Power: When the Ambient Temperature is 73.4 °F, the maximum stable power that we can read in the Feminine Wash mode would be the following: inlet water static pressure is  $29 \pm 2.90$  PSI, inlet water temperature is 59 °F, seat temperature (high), water temperature (high), and water pressure (high).

