



# ProStock

Electronic Bidet with  
Integrated Toilet

#PSBTWE1000



## **OPERATOR'S MANUAL**

# OPERATOR'S MANUAL

Thank you for your ProStockelectronic bidet purchase! Please read and follow the instructions carefully before installation. Save this manual in a secure location for maintenance and future reference.

*\*We reserve the right to the final interpretation of this manual. This manual is subject to change without notice.*

## IMPORTANT SAFEGUARDS

Basic safety precautions must be followed when handling or using electrical products, especially those within the reach of children. Please be make yourself aware of the following guidelines:

1. This appliance should only be used by children who are 8 years and above or by persons with disabilities who have received supervision and instructions on the safe use and the hazards involved when using this appliance.
2. It is unwise to allow children to play with this electronic bidet, supervised or otherwise.
3. It is not recommended that children who are unsupervised be allowed to clean and perform maintenance for this bathroom fixture.

## READ ALL INSTRUCTIONS BEFORE USING.

### **DANGER**

To reduce the risk of electrocution, please ensure the following procedures are adhered to:

- Do not use while bathing.
- To keep it from falling or breaking, do not put or store these product at an elevated height.
- Do not drop or place the product in any wet area.
- Do not touch the appliance if it is soaked in water. Immediately unplug from power.
- Do not wash the electrical plug with water or detergent.
- Do not touch the electrical plug with wet hands.
- Do not block the outlet of the air dryer with any object or even with your hand.
- Never disassemble, or modify this product.
- During the installation, disassembly, repair, or maintenance of this product, the power plug must be removed and the water supply must be shut off.

## **WARNING**

To reduce the risk of burns, electrocution, fire, or injury please ensure the following procedures are adhered to:

- Close supervision is necessary when this product is used by, on, or near children or persons with disability.
- Use this product only for how it is intended and how it is described in this manual. Do not use attachments that are not recommended by the manufacturer.
- Do not operate this product if it has a damaged cord or plug.
- Do not operate this product if it is not working properly. Contact customer service for assistance.
- Do not operate this product if it has been dropped or damaged.
- Do not operate this product if it is soaked in water.
- Keep the cord away from heated surfaces.
- Do not use when you are sleepy or drowsy.
- Never try to stop the flow of any opening or hose.
- Do not use outdoors.
- Keep the electronic bidet away from any contact to aerosol (spray) products or administered oxygen.
- Only connect this product to a properly grounded outlet. See grounding Instructions.
- Do not throw cigarettes or any burning materials into the toilet.
- This is an electric appliance and must be placed away from water. Please do not keep it soaked with any types of liquid.
- Do not touch the sides or any part of the product during an electrical malfunction.
- It is not recommended, and will void the warranty to plug another appliance in the same outlet this product is plugged into.
- It is not recommended, and will void the warranty to use this appliance through an extension cord or an unstable loose outlet.
- An old or worn out water supply hose should not be used. Installation of the bidet seat should include specific components and a new water supply hose.

## CAUTION

Indicates that failure to follow the instruction may cause body injury or property damage.

- Do not install or use the product in wet places (i.e. steam room, etc.).
- It is recommended to use water-proof electrical outlet which should be installed in a place where it will not easily get wet.
- This product should only be used with AC 110-120V, 50/60Hz electrical current with at least a 15A load current. The power plug must be equipped with either a ground fault circuit interrupter, a ground fault electrical leakage protector, or a similarly high sensitive, rapid type leakage switch. (Rated sensitive current under 15mA)
- It is recommended to pull out the power plug during a thunderstorm to avoid power surge damage.
- Do not stand on this product.
- The ceramic toilet must be installed and secured using closet bolts.
- Do not stand on the product unit, the seat, and the cover.
- To avoid damage to the seat when using the product, do not lean against the seat cover.
- This product is equipped with a soft-closing seal cover. Heavy pressing or pushing may damage the soft-closing damper.
- Do not use lacquer thinner, petrol, liquid medicine, detergent, insecticide, toilet cleanser, and scrubbing brush in cleaning the product.
- It is not recommended, and will void the warranty to expose the product to direct sunlight for extended lengths of time.
- To avoid chafing and maintain cleanliness, only use a tap water or potable water supply
- Do not connect the water supply to the heater outlet. Make sure the inlet water temperature ranges from 33 to 95 degrees Fahrenheit.
- When the room temperature drops below 32 degrees F, please drain and dry up the water tank and water lines to avoid damage due to freezing.
- Raise the room temperature to keep the toilet from damage due to freezing.
- When moving the product from a cold or wet environment to normal room temperature, wait for 2 hours until the condensed water becomes fully volatilized. Doing so can prevent the product from electrical short-circuit.
- Stop using the product and shut off the power if the product malfunctions.
- In case of malfunctions, please contact technical support for professional service.

## GROUND INSTRUCTIONS

This product should be grounded. In the event of an electrical short circuit, grounding reduces the risk of electric shock by providing an escape wire for the electric current. This product has a cord equipped with a grounding wire and a grounding plug. The plug must be connected into an outlet that is properly installed and grounded.

### **WARNING**



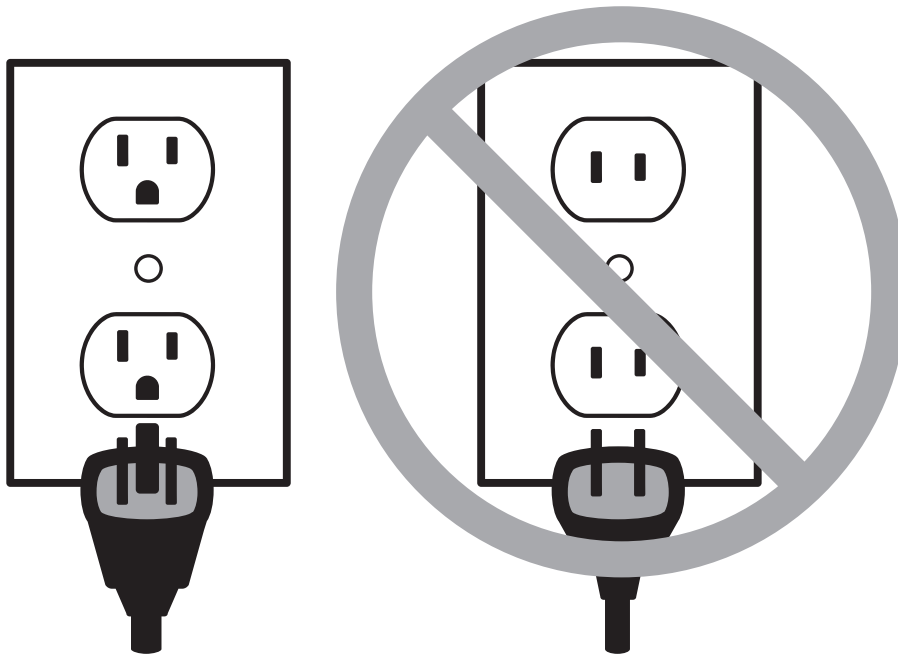



Improper use of the grounding plug can result to a risk of electric shock.

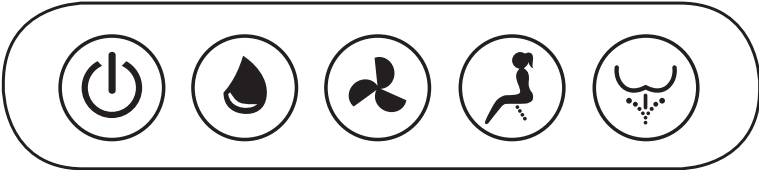

If repair or replacement of the cord or plug is necessary, do not connect the grounding wire to either flat blade terminals. The grounding wire is the insulation wire with a green surface that does or does not have stripes.

This product is equipped with a specific electric cord and plug to permit connection to a proper electric circuit. Make sure that the product is connected to an outlet that has the same configuration as the plug. No adapter should be used with this product. DO NOT modify the plug provided - if it will not fit the outlet, have the proper outlet installed by a qualified electrician. If the product needs to be reconnected for use on a different type of electric circuit, the reconnection should be made by qualified service personnel.

## Illustration of Main Unit Keys

		
	<b>Power</b>	<p>1. Hold “power” button to enter standby mode and then briefly press “power” button to restore to functional mode.</p> <p>2. When someone sits, press “power” button to stop the function of the rear and front cleaning and drying. With no one sitting on the unit, press “power” button to switch between the function mode and the power safe mode.</p>
	<b>Flush</b>	Press “flush” button to activate full flushing
	<b>Dry</b>	Press the “dry” button to turn on warm air dryer. After the user leaves the seat, it will automatically stop.
	<b>Front</b>	Press the “front cleaning” button and the water will come out to clean the front portion of the body. It will automatically stop after 1 cleaning cycle. Once you press the “stop” or “power” button, the function will immediately stop.
	<b>Rear</b>	<p>1. If you press the “rear cleaning” button, the water will come out to clean the rear portion of the body. It will automatically stop after a 1 cleaning cycle. Once you press the “stop” or “power” button, the function will immediately stop.</p> <p>2. When no one is using the toilet, you can press the “rear button” for the wand to extend out for cleaning.</p>

### Note:

1. When the main unit is in functional mode, the light of the “power” button stays on. When in energy saving function, the light of the “power” button goes off and the energy saver light turns on. When In standby mode, both lights are off.
2. The default setting of all functions is on the medium level. After using the controller, settings default back to how it was set during the last use.



# AUTO LID OPEN/CLOSE

## 1. When user is close to the toilet---

- When the user is close to the seat and the human body sensing window detects the action of the user, the power and energy-conservation indicator lights up and then the seat cover automatically opens.
- In summer, when the room temperature is above 85 degrees, the temperature difference between the user and the surrounding will get smaller, depriving the sensor to properly detect the user's action. When this happens, please use the controller to open/close the seat cover.

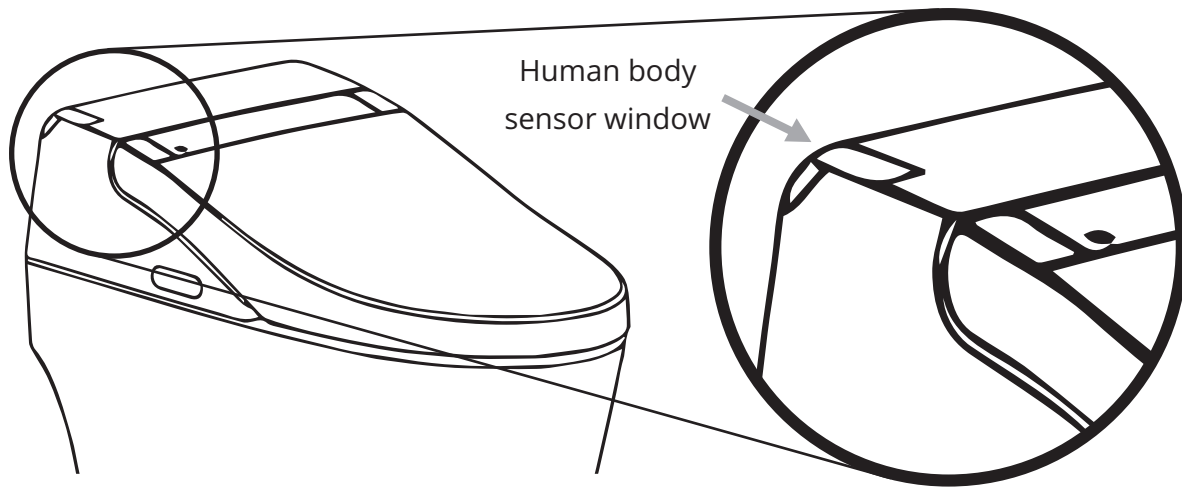

2. The seat cover will automatically close 60 seconds after the user leaves.

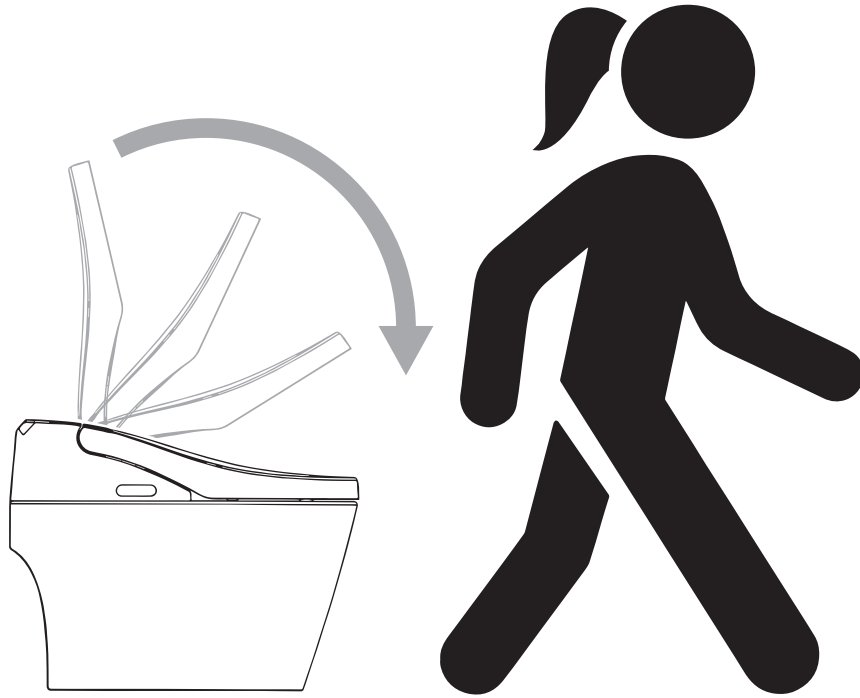

**3. When men stand to use the toilet---**

- Open the seat using your hand or the remote control.
- The lid and seat will be closed 60 seconds after the user leaves.

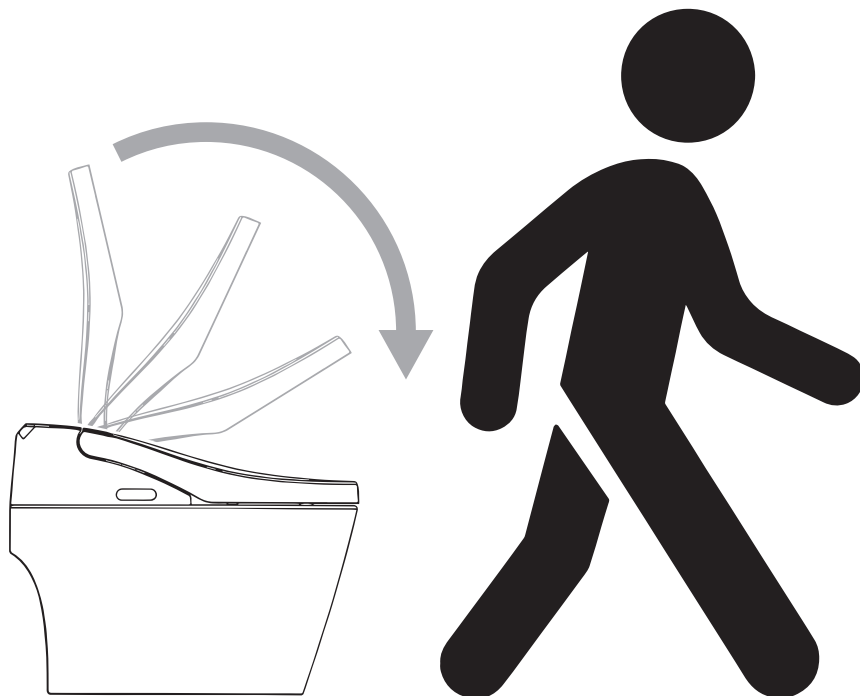



# DAILY MAINTENANCE

## Electronic Bidet Care and Maintenance

1. Turn off power supply during maintenance.
2. Turn the seat upward to open. Press down the button located on the right side of the main unit and pull the seat out. Wipe any stains with a soft damp cloth.
3. Safety self-inspection. After cleaning, reconnect the toilet to the power supply.

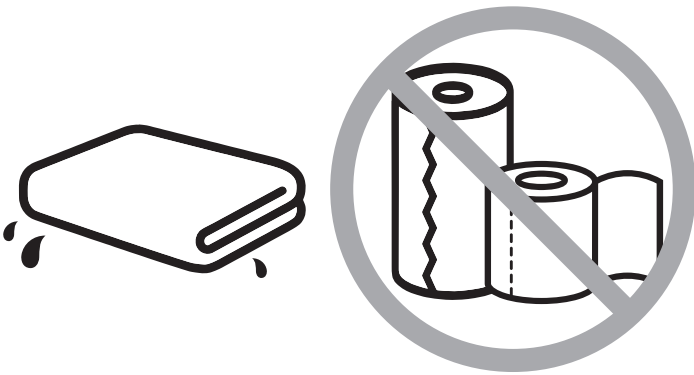
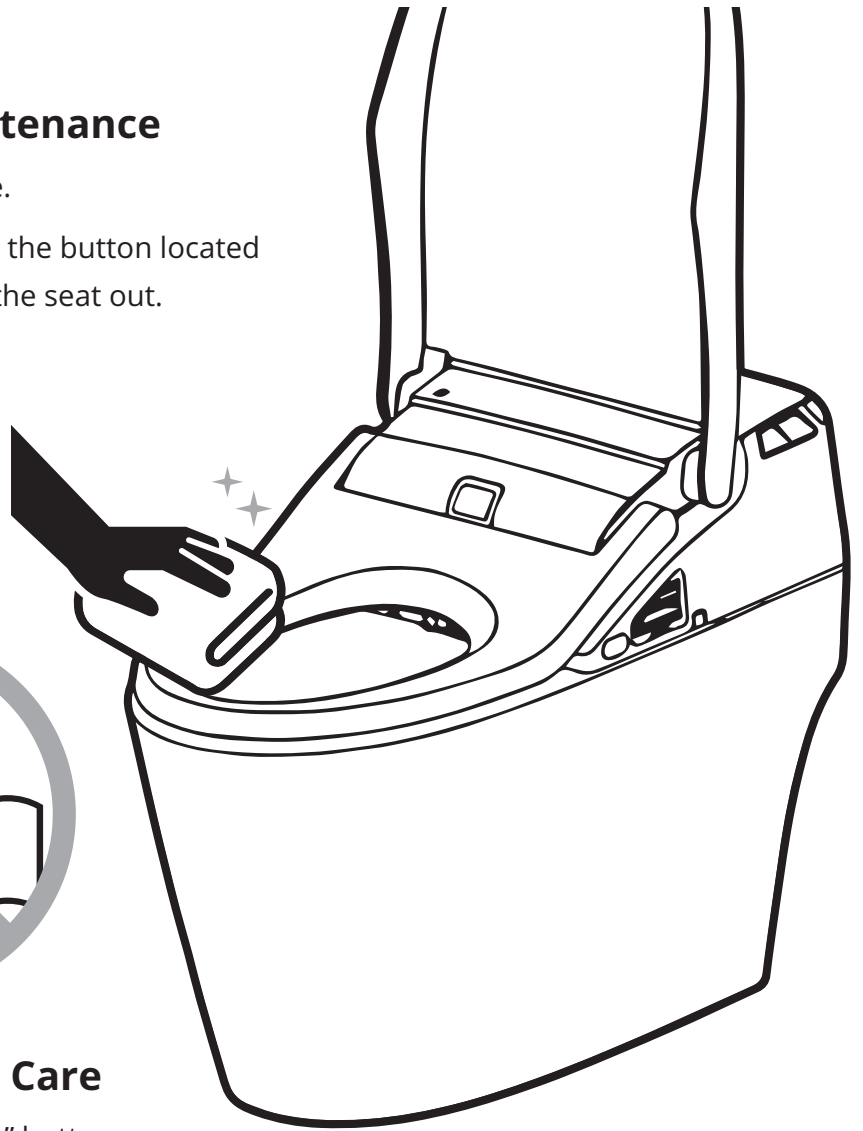

## Spray Nozzle Maintenance and Care

1. Nozzle self-cleaning. Press “nozzle cleaning” button and the nozzle will move forward and self-clean.
2. Spray nozzle disassemble. With the wand extended, the nozzle can be disassembled for cleaning.
3. Use a soft cloth or soft brush to clean. Do no pull or push the wand to avoid damage.
4. Nozzle assembly. Re-install the nozzle to the wand and press the “nozzle cleaning” button. The nozzle will move back to its original position.

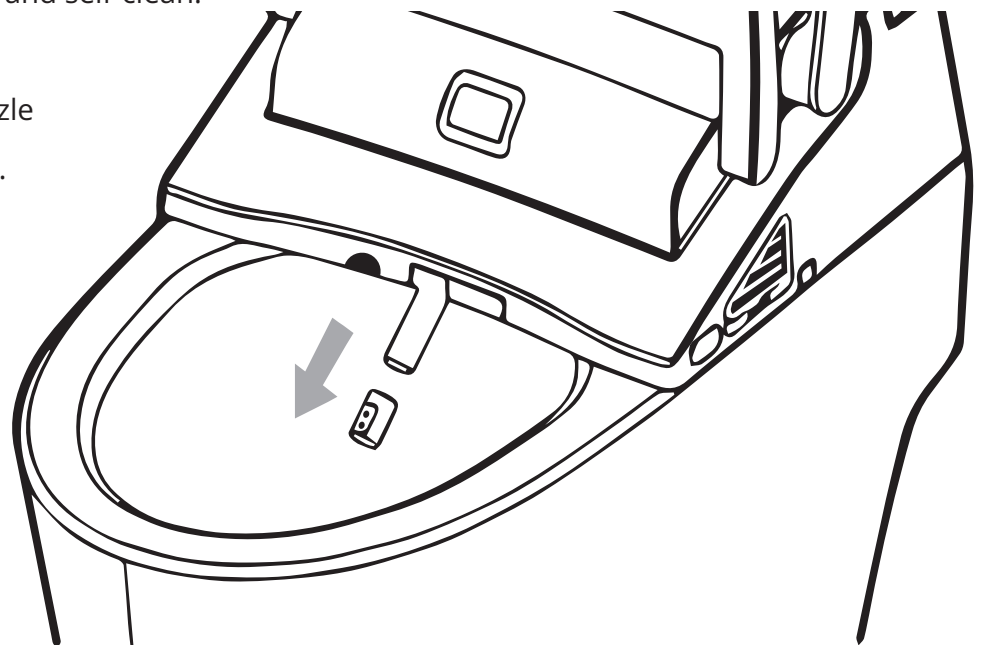

# EMERGENCY TROUBLESHOOTING

## Electricity and Water Supply Issues

### 1. Power failure.

Manually press the appropriate button for full or half flush to perform manual flushing.

### 2. Water failure.

Use a bucket to pour 1-2 gallons of water to flush the contents of the bowl.

Avoid spilling water from the bowl.

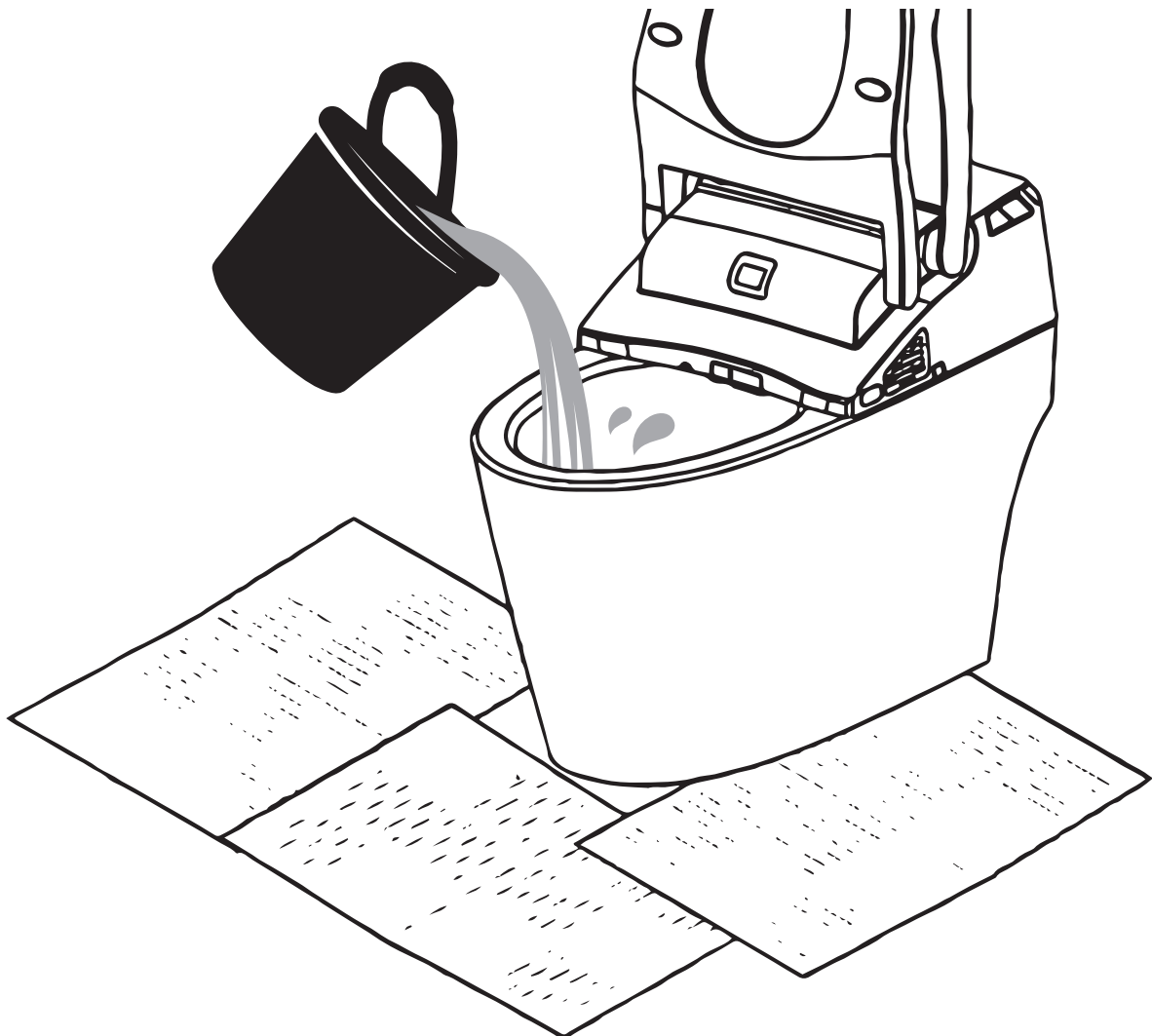
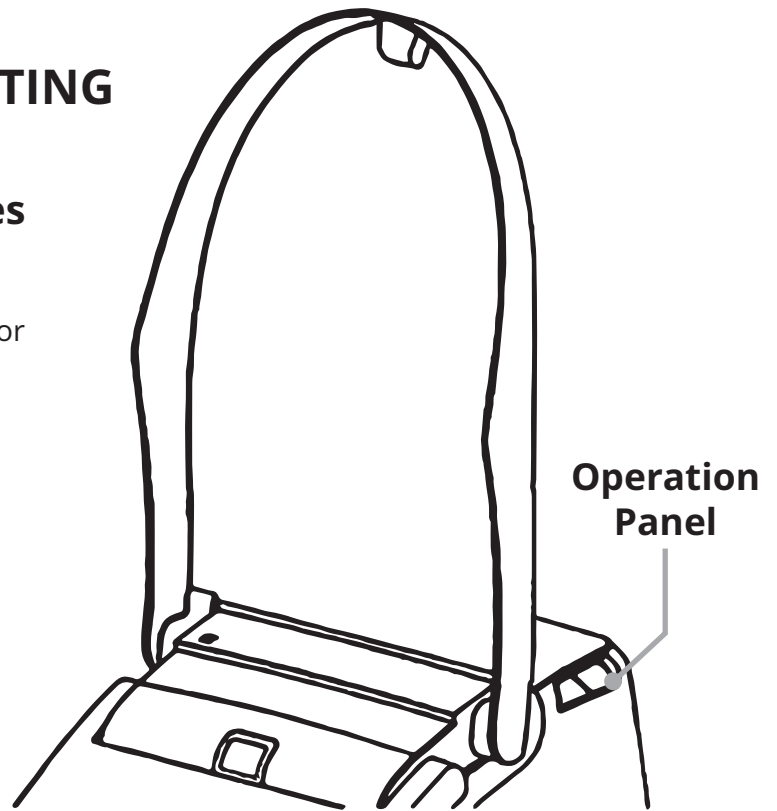

## Failure of Remote Control

1. Manually operate the panels on the Electronic Bidet seat to use it.

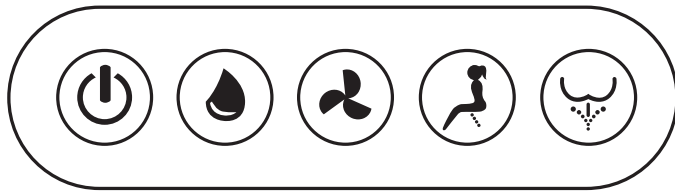

2. Battery replacement.

- Press the “power” button on the panel and the electricity indicator will turn off.
- Take remote control from the hanger.
- Open battery cover to replace the batter then but the control back to the hanger.
- Press the “power” button again and the electricit indicator may turn on.

**Note:** When replacing the battery, the automatic function and timing function will be cancelled. The settings need to be reset.

## Product is left Unused for a Long Period of Time

- Especially during the winter season, the water inside the tank has to be discharged to avoid freezing.

### To Discharge Water

1. Turn of the water supply angle valve.
2. Disconnect or remove electrical power.
3. Discharge water.

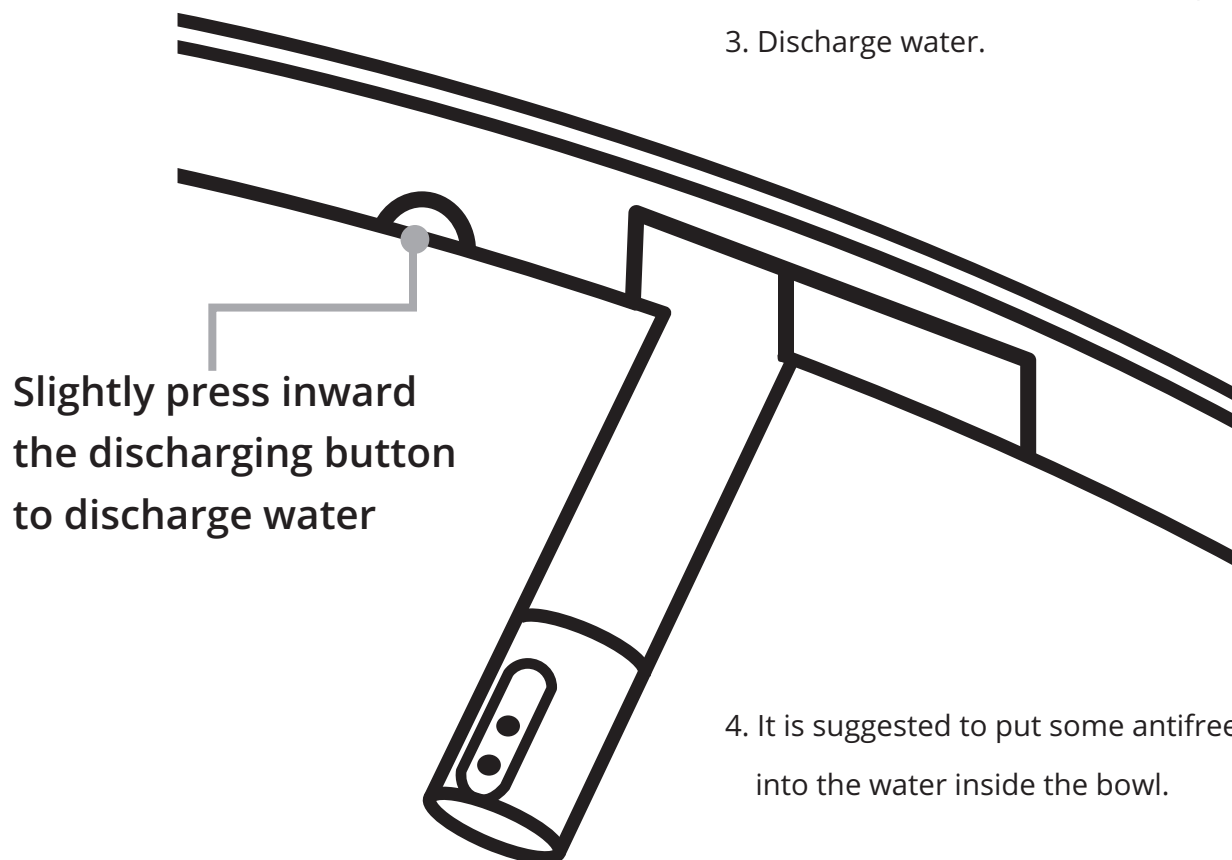

4. It is suggested to put some antifreeze into the water inside the bowl.

 **Note:** Before discharging the water, the power must be cut off.

# TROUBLESHOOTING GUIDE

PROBLEM	CAUSE	SOLUTION
<b>No flushing</b>	Water supply line is kinked, restricting flow	Unkink the supply line
	Fill valve is off	Turn on the fill valve
	Water supply is turned off	Connect the water supply and wait for the water
<b>Poor flushing</b>	Water supply line is kinked, restricting flow	Unkink the supply line
	Fill valve is not fully turned on	Fully turn the valve on
	Filter is dirty which causes the block	Clean the filter
<b>The water is not hot</b>	The water temperature is set at normal temperature level	Reset the water temperature
<b>Seat temperature is not hot</b>	The seat temperature is set to normal	Reset the seat temperature
	In standby mode	Shift to function mode for 3 minutes
<b>Air dry temperature is not hot</b>	The wind temperature is set at a normal temperature level	Reset the wind temperature
<b>No wind blowing out</b>	In standby mode or power save mode	Shift to function mode to use the dry function
<b>Spray wand cannot be retracted</b>	Power off	Lightly push the wand back and wait for the power
	Got stuck because of impurities	Clear away the impurities
<b>Spray wand cannot stretch out</b>	Power off	Lightly push the wand back and wait for the power
	Not sitting on the sensing area	Properly sit in the sensing area
<b>Controller cannot display</b>	The polarity of the battery is reversed	Properly install the battery
<b>Malfunction of deodorization</b>	The user can't properly reach the sensing area in the seat	Adjust to reach the sensing area
 <b>CAUTION</b>	If the problems cannot be solved through the methods mentioned above, please shut the power off and the contact the service provider for maintenance.	
	If the leakage circuit breaker often trips off, it means that the product has electricity leakage so please shut the power off and contact the service provider for maintenance.	

# PARTS IDENTIFICATION

## LEFT SIDE

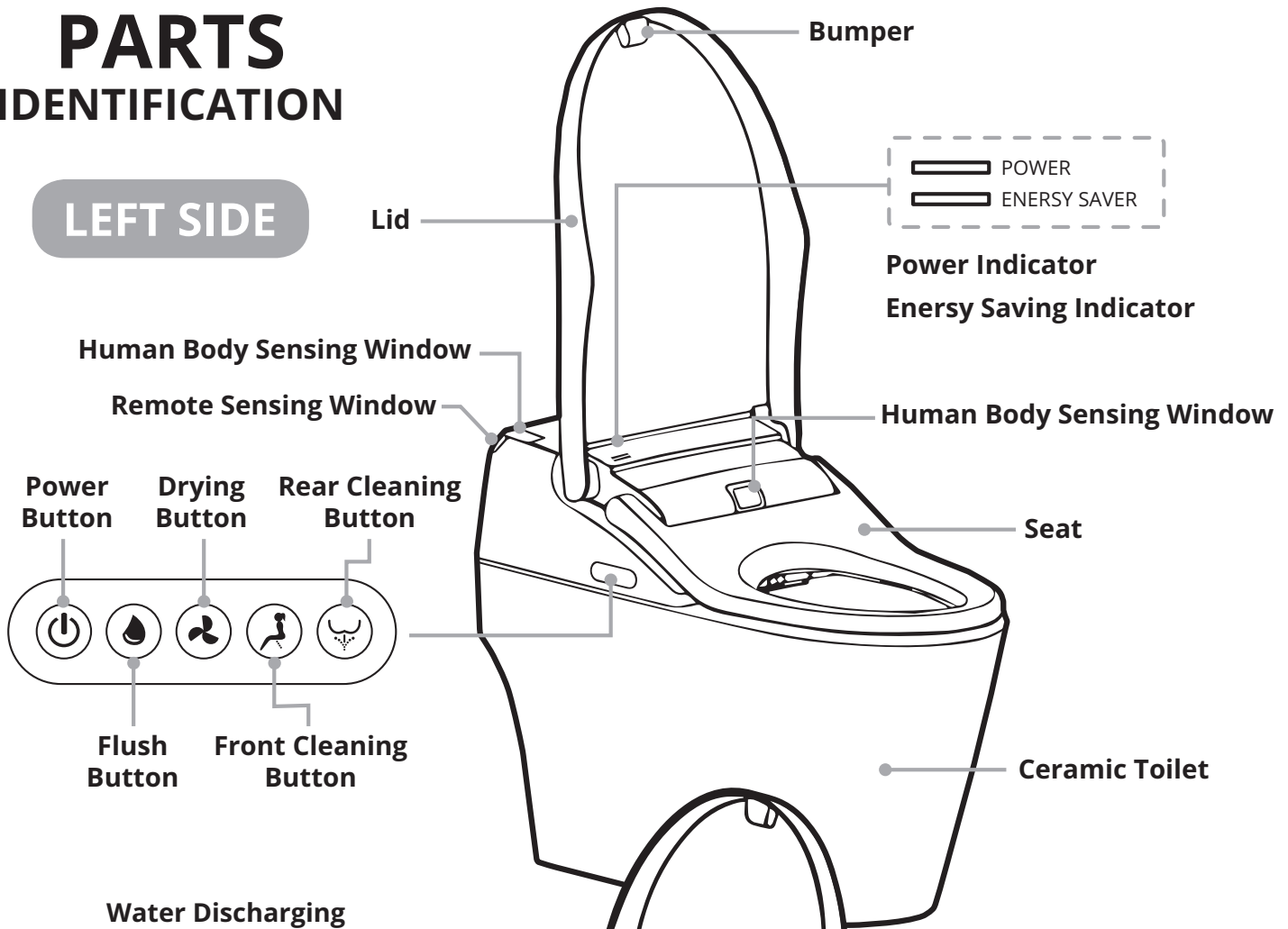

## RIGHT SIDE

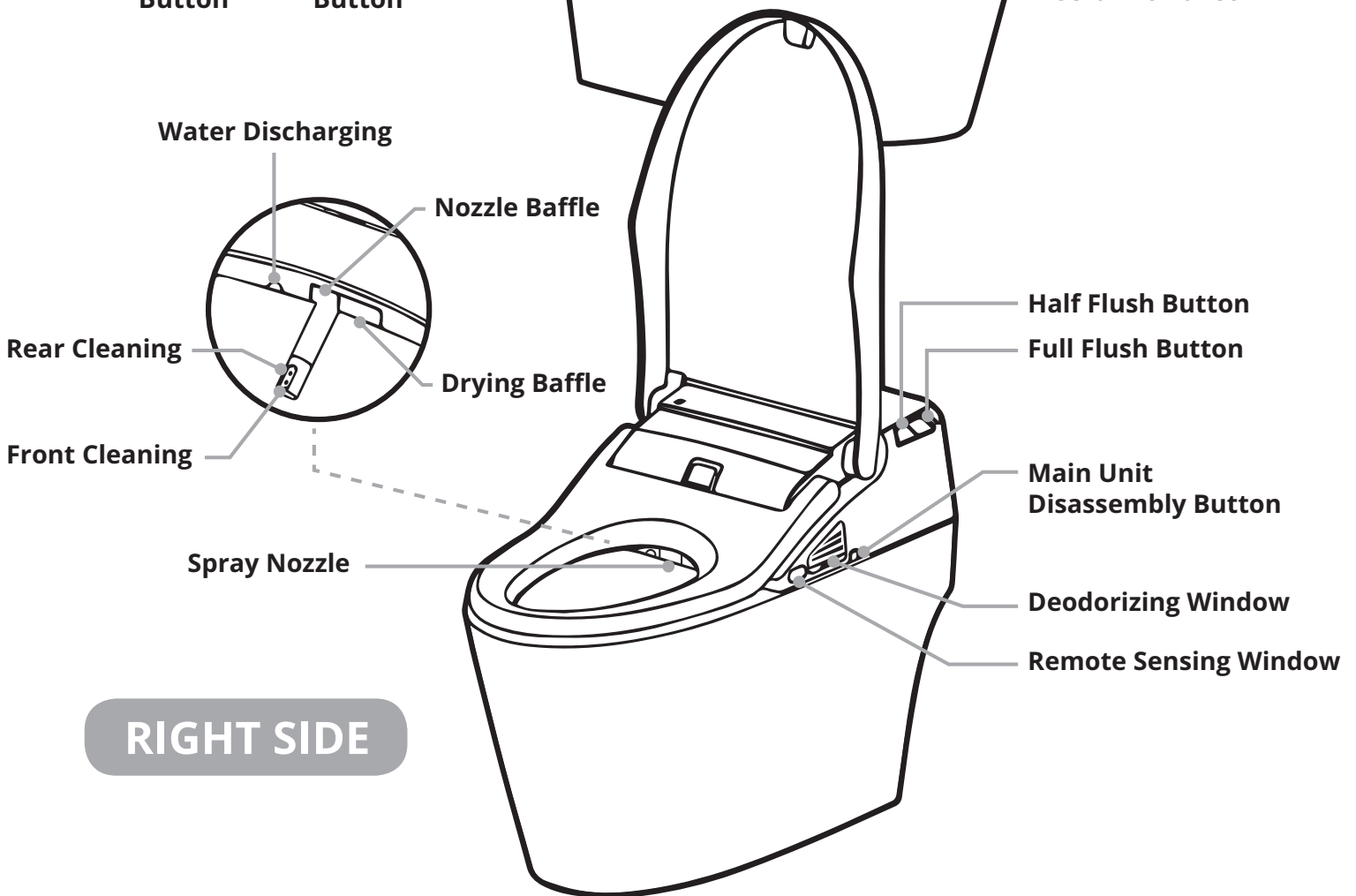

# Warranty

## PRODUCT LIMITED WARRANTY

**Thank you for your ProStock Purchase.** This product has a one (1) year warranty for free repair or replacement due to problems arising out of defects in workmanship while being used in accordance to the installation manual and usage cautions.

If the product does not work properly during the warranty period, please contact customer service.

Proof of purchase must be presented to obtain free service under the coverage of this warranty.

Our company reserves the right to replace the product with other similar models.

We can fix or repair the product at a reasonable service charge after the expiration of the warranty period.

Service charges shall be paid even during the warranty period if breakage or damage is caused by any of the following events (including but without limitation):

1. The user's negligence or mistake during operation, unreasonable repair, or alteration.
2. Product is damaged by negligence or mistake during the installation process.
3. The movement of the installation location of the product.
4. Using the product outside of intended use in residential housing or commercial hotels.
5. The use of non-specified power supply (voltage, rating pressure).
6. Dirt, sand, and other impurities in water supply causing invalid operation.
7. Damages due to force majeure (including but not limited to natural disaster) or other incidents.
8. The user fails to use in compliance with the warning or caution described in the installation manual.

The purchasing date is subject to the purchasing invoice or the receipt.

Please keep the warranty and invoice/receipt available for future repair and maintenance.







# ProStock

Installation Guide for  
Electronic Bidet with  
Integrated Toilet

#PSBTWE1000

